

# Connecting PVG-C-D1 for Rapid Shutdown System

Application Note: PVGD1-20190610  
Version: 5.0

**WARNING:**

PVG is a device with memory. If the last state of a PVG is unknown, please test and confirm it is at OFF state before wiring. ON state PVGs may result in high voltage on the PV strings.



While plugging or unplugging PV connections in a system, inverter should be fully disconnected or deactivated and there should be no current on PV cables.

# 1 Executive Summary



PVG-C-D1 is a din rail mount PVG controller. It has the following key features:

- It can be mounted on a din rail, and can be installed inside a PV wiring box or a PV inverter
- It is directly powered by AC power grid, 100Vac to 277Vac, and lower/zero voltage and high voltage ride through
- It supports primary/secondary mode
- It supports ON-GRID and OFF-GRID mode
- It supports RS485 communications, and can be connected to BDG-256 gateway for monitoring individual PVGs.

This application note describes the details on connecting PVG-C-D1.

# PVG-C

AC		RS485		RELAY		PV-PLC		E-STOP		BDG-256		
L	N	A	B	-	+	CORE-1	CORE-2				1	2

## 2 Wiring the PVG-C-D1 controller

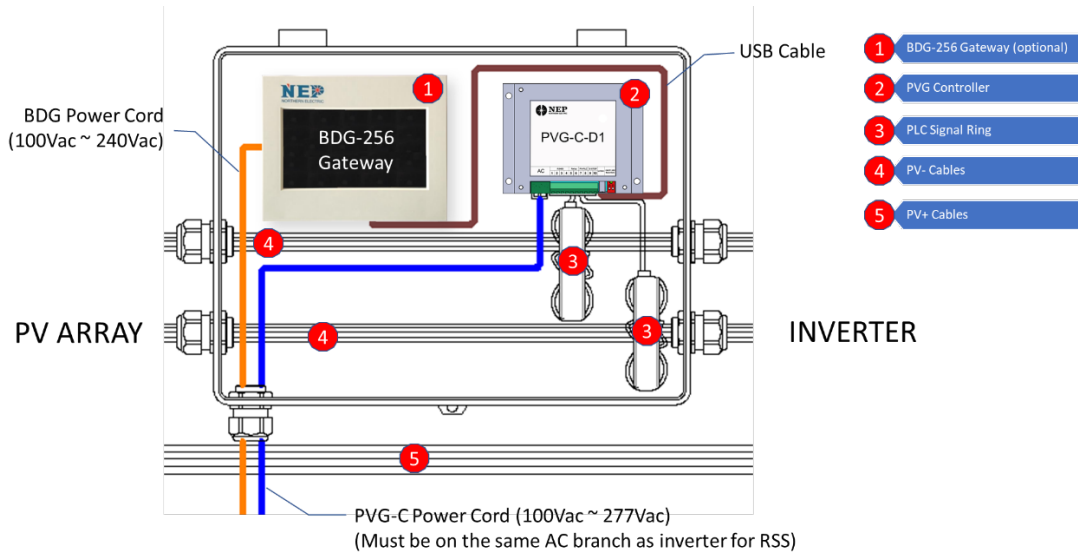

## 3 PVG-C-D1 connecting pins

### 3.1 AC power supply



PVG-C-D1 is directly powered by AC, from 240Vac to 277Vac. Once the AC power supply is lost, the PVG-C-D1 sends command to PVG or any SunSpec compliant RSD receivers to disconnect (if the PVG-C-D1 is set as “ON-GRDI mode”). Within 1 second, the PVG-C-D1 does nothing and ride through the low/zero voltage or high voltage spike. After the power grid is recovered to normal, the PVG-C-D1 sends command to PVG or any SunSpec compliant RSD receivers to connect.

In secondary mode, loss of AC main signal may override the command from the primary PVG-C-D1 controller.

### 3.2 RS485 communications



For a system using multiple PVG-C-D1 controllers, all PVG-C-D1 can be linked together through RS485 communication cable. This RS485 networks can be used to support primary/secondary mode of operation.

- Once primary detects an event for rapid shutdown or restore connection from rapid shutdown, it commands all secondaries through RS485 communication network.
- All secondary PVG-C-D1 communicate to the BDG-256 gateway connected to the primary PVG-C-D1 through the RS485 network

### 3.3 Relay output



For some systems, a relay is desired for a synchronized command of RSD. These two pins can be used to drive a 5V, 50mA maximum relay. Once RSD disconnect command is initiated, a 5V is output on these two pins. Once RSD disconnect command is stopped, the 5V output stops simultaneously.

PV-PLC

CORE-1 CORE-2

### 3.4 PV-PLC

One PVG-C-D1 can be connect to up to two toroid rings for PV-PLC communications. The PV-PLC communication rings (part number PVG-R) can be got from NEP.

### E-STOP

### 3.5 E-Stop connections

A dry contactor such as an E-Stop can be connected to these pins. Once two pins are **short** through the dry contactor, the PVG-C-D1 controller sends command of disconnect to all PVGs or any SunSpec compliant RSD receivers. Once these two pins are **open**, the PVG-C-D1 controller sends command of connect to all PVG or any SunSpec compliant RSD receivers.

In secondary mode, sending disconnect command by pushing the E-stop button may override the commands from the primary PVG-C-D1 controller.

BDG-256

### 3.6 USB port for connecting a BDG-256 gateway

A BDG-256 gateway can be connected through the USB port “BDG-256” and collects panel level monitoring information from PVGs. Further, by connecting this BDG-256 gateway, remote monitoring through NEPVIEWER (<http://www.nepviewer.com>) is supported. Details on setup BDG-256 is in a separate document (BDM-2015122001\_BDG\_256\_quick\_guide).

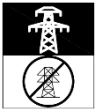

### 3.7 ON-GRID / OFF-GRID switch

A PVG-C-D1 can be set as for ON-GRID (default) or for OFF-GRID. By setting to OFF-GRID, loss of AC power supply does not trigger a rapid shutdown. The only way to trigger RSD is through the E-STOP.

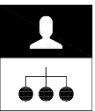

### 3.8 PRIMARY / SECONDARY switch

A PVG-C-D1 can be set as a PRIMARY (default) or SECONDARY. Each RSD system can have only one primary and multiple secondaries. Primary and secondaries are connected through the RS485 cables.

The PRIMARY PVG-C-D1 can command all RSDs, including RSDs controlled by SECONDARY PVG-C-D1, to connect or to disconnect. Further, a BDG-256 gateway can be plugged in the primary PVG-C-D1 controller (see 2.6) and monitor each and every PV panel of the whole RSD system including PV panels controlled by SECONDARY PVG-C-D1 controllers.